

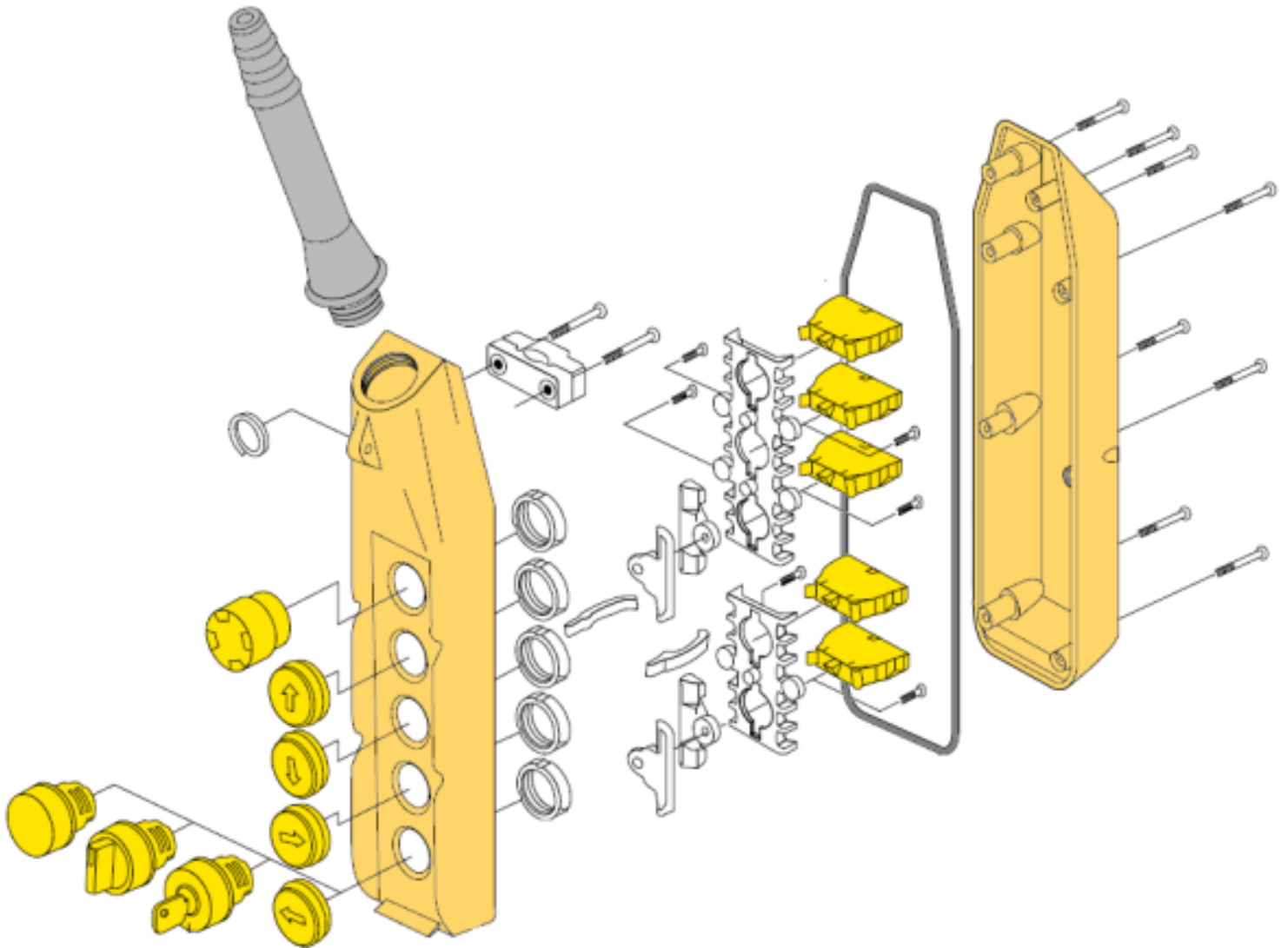

GIOVENZANA PAINIKEOHJAIMIEN OSAT





PRODUCT DESCRIPTION

Giovenzanan painikeohjaimia on saatavana myös kalustamattomina jolloin ne on mahdollista varustella tarpeen mukaan. Kahden painikkeen interlokkit ja muut tarvikkeet tulevat kotelon mukana.

PAINIKELOHKOT



1 NC	PL004001
1 NO	PL004002

KAKSI NOPEAT



A 2 VEL. NO+NO 1NO+1NO	PL004010
---------------------------	----------

KIERTOKYTKIMET



0-1	PL006001
1-0-2	PL006002



0-1	PL007001
1-0-2	PL007002

HÄTÄSEIS PAINIKKEET



WITH VISION STANDARD	PL013001 PL013002
-------------------------	----------------------



PL013003

LAMPUNPIDIKKEET JA KUVUT



BA9s	PL004007
------	----------



1	2	PL00800.
3	4 □ 5	

PAINIKKEET



WITH VISION STANDARD	PL013001 PL013002
-------------------------	----------------------



PL013003





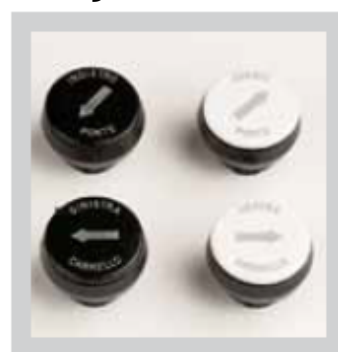

































LAMPUNPIDIKKEET JA KUVUT

COLOUR	CODE
	PL005034
	PL005035
	PL005036
	PL005037
	PL005038
With engraving	PL0050...*





PAINIKKEIDEN SYMBOLIT

 PL005004	 PL005019	 PL005012	 PL005027	 PL005023	 PL005008	 PL005031	 PL005016	 PL005001	 PL005002
 PL005005	 PL005020	 PL005013	 PL005028	 PL005024	 PL005009	 PL005032	 PL005017	 PL005003	 PL005034
 PL005006	 PL005021	 PL005014	 PL005029	 PL005025	 PL005010	 PL005033	 PL005018	 PL005035	 PL005036
 PL005007	 PL005022	 PL005015	 PL005030	 PL005026	 PL005011			 PL005037	 PL005038



PAINIKEOHJAIMIEN KOTELOT

PL



DESCRIPTION	CABLE ENTRY Ø	CODE	WEIGH gr	MIN. PACK QTY	DIMENSIONS																				
Pendant station with 5 holes	7...18	PL05K	410	1																					
Pendant station with 7 holes		PL07K	540	1																					
Pendant station with 8 holes	9...21	PL08K	600	1	<table border="1"> <thead> <tr> <th>N° FORI</th> <th>A</th> <th>B</th> </tr> </thead> <tbody> <tr> <td>5</td> <td>345</td> <td>288</td> </tr> <tr> <td>7</td> <td>495</td> <td>358</td> </tr> <tr> <td>8</td> <td>530</td> <td>393</td> </tr> <tr> <td>10</td> <td>640</td> <td>463</td> </tr> <tr> <td>12</td> <td>710</td> <td>533</td> </tr> </tbody> </table>			N° FORI	A	B	5	345	288	7	495	358	8	530	393	10	640	463	12	710	533
N° FORI		A	B																						
5		345	288																						
7		495	358																						
8	530	393																							
10	640	463																							
12	710	533																							
Pendant station with 10 holes	PL10K	700	1																						
Pendant station with 12 holes	PL12K	800	1																						

PLB



DESCRIPTION	CABLE ENTRY Ø	CODE	WEIGH gr	MIN. PACK QTY	DIMENSIONS																							
Pendant station with 4 holes	9...21	PLB04K	410	1																								
Pendant station with 6 holes		PLB06K	510	1																								
Pendant station with 8 holes	12...24	PLB08K	610	1	<table border="1"> <thead> <tr> <th>CABLE ENTRY Ø</th> <th>A</th> <th>B</th> </tr> </thead> <tbody> <tr> <td>4</td> <td>345</td> <td>185</td> </tr> <tr> <td>6</td> <td>399</td> <td>239</td> </tr> <tr> <td>8</td> <td>453</td> <td>293</td> </tr> <tr> <td>10</td> <td>547</td> <td>347</td> </tr> <tr> <td>12</td> <td>601</td> <td>401</td> </tr> <tr> <td>14</td> <td>655</td> <td>455</td> </tr> </tbody> </table>			CABLE ENTRY Ø	A	B	4	345	185	6	399	239	8	453	293	10	547	347	12	601	401	14	655	455
CABLE ENTRY Ø		A	B																									
4		345	185																									
6		399	239																									
8	453	293																										
10	547	347																										
12	601	401																										
14	655	455																										
Pendant station with 10 holes	PLB10K	710	1																									
Pendant station with 12 holes	PLB12K	810	1																									
Pendant station with 14 holes	PLB14K	910	1																									



PAINIKEOHJAIMEN RÄJÄYTYSKUVA

PL - P02 - P03 Single row

Note: For execution "empty enclosures in kit", the parts "yellow underline" 07, 09, 10 and 11 will must be order separatly.

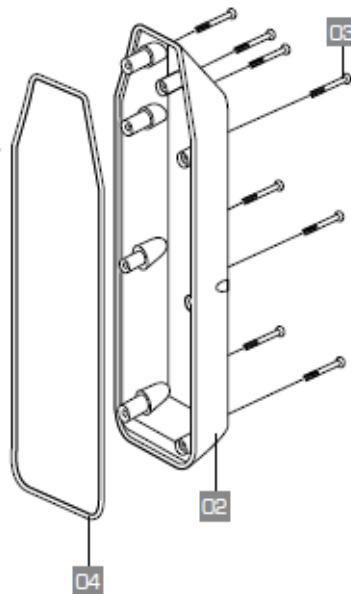
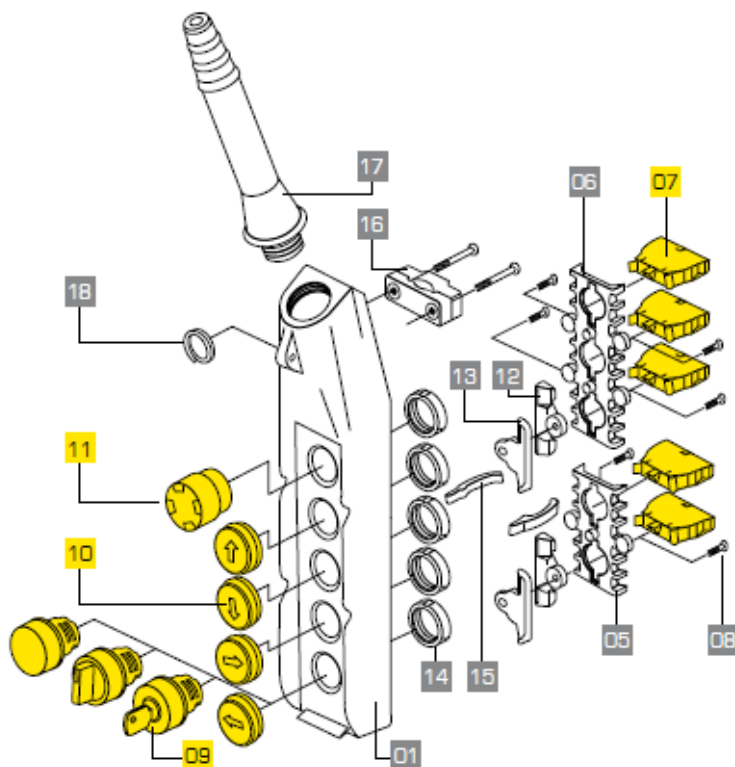

N°	REF. NO	DESCRIPTION	QTY.
01	PLO0100.	SINGLE ROW PENDANT STATION COVER...PUSH BUTTONS	1
02	PLO0200.	DOUBLE ROW PENDANT STATION BASE...PUSH BUTTONS	1
03	11606022	SELF TAPPING STAINLESS STEEL INOX SCREW 4X30	..
04	11901028	RUBBER GASKET Ø 2,5	MT..
05	PL003001	2-HOLES CONTACT BLOCKS SUPPORT	..
06	PL003002	3-HOLES CONTACT BLOCKS SUPPORT	..
07	PL004001	1 NC CONTACT BLOCK	..
	PL004002	1 NO CONTACT BLOCK	..
	PL004010	2 SPEEDS 1NO+1NO CONTACT BLOCK	..
	PL004007	LAMP HOLDER	..
08	11607007	SELF TAPPING SCREW 3,9X13	..
09	PL00700.	ROTARY SWITCH	..
	PL00600.	KEY SWITCH	..
10	PL00800.	PILOT LIGHT	..
	PL0050..	ENGRAVED PUSH BUTTONS	..
11	PLD13001	MUSH-ROOM OPERATOR TURN TO RELEASE WITH VISION	1
12	PL011002	BOTTOM MECHANICAL INTERLOCK	..
13	PL011001	TOP MECHANICAL INTERLOCK	..
14	11705100	M. 22 ZAMA LOCK NUTS	..
15	PL012001	CABLE CLAMP LEVER	..
16	12904014	COMPLETE CABLE CLAMP	1
	12906006	PL05 CABLE SLEEVE	..
17	12906004	PL07 - PLO8 CABLE SLEEVE	..
	12906005	PL10 - PL12 CABLE SLEEVE	..
18	12003009	SUNSPENSION RING	1

ASSEMBLY INSTRUCTION FOR 1^a - 2^a SPEED CONTACT BLOCKS

PL004010

PL004003 1^a speed

PL004004 2^a speeds

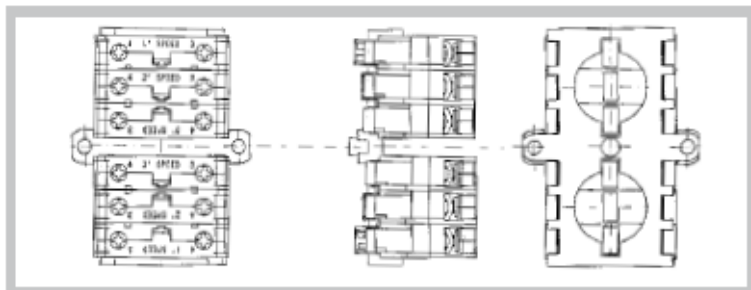



TUOTETEKNO OY
NOSTO- JA SIIRTOLAITTEET

Tuotetekno Oy
Täyden palvelun nosto- ja siirtolaitetalo